

CARMATE

AILEBEBE

# SWING MOON

## Operating Instructions

- If this child seat is not installed correctly or is not used properly, its performance may be compromised. You must check before installation whether or not your vehicle can properly accommodate a “Universal” assistant restraining device for a child, by referring to the owner’s manual for the vehicle.
- For safe usage, please read these operating instructions carefully to understand their contents. If they are not clear, contact our company (see the back cover) or CARMATE dealer.

This child seat is approved in accordance with European Safety standard ECE R44/04 under following conditions; (Group: I, II, Universal category)

- Usable only for a child whose weight is from 9 to 25 kg.
  - A passenger seat that is confirmed to be able to properly accommodate a “Universal” assistant restraining device for a child by the owner’s manual for the vehicle.
- Refer to the operating instructions for details.

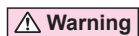

**Warning**

Keep the protective plastic of the child seat out of the reach of small children after opening the package. If a child gets wrapped up in it, it may cause suffocation.

2070722B

For Safe Usage

Packing Contents and Parts Identifications

Before Use

Usage in Child Style

Usage in Junior Style

Maintenance

MEMO

EN

## Introduction

Thank you for purchasing AILEBEBE SWING MOON.

For safe usage, please read these operating instructions carefully to understand their contents. We shall not be held responsible for any trouble caused by incorrect installation or usage.

- Check in the owner's manual for the vehicle whether or not your vehicle can properly accommodate a "Universal" assistant restraining device for a child. If something is not clear, contact a local dealership or "Where to contact" on the back cover.
- There can be a case due to the vehicle that the child seat cannot be reclined.
- The operating instructions are necessary for each use of the child seat. Keep them in the bottom of the child seat base.

This child seat is an assistant device for a child, designed to prevent or at least minimize injury from a collision or sudden stop. It cannot protect a child in every case of severe collision. We sincerely remind you of the importance of safe driving.

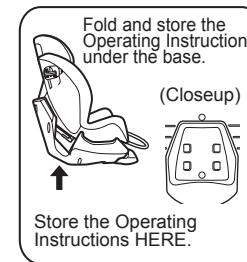



## Table of contents

<b>1. For Safe Usage .....</b>	<b>4-11</b>	<b>5. Usage in Junior Style .....</b>	<b>33-38</b>
Regarding the Safety Descriptions .....	4	Preparation before use .....	33-35
Requirements .....	4	Storing the harnesses/Preparation of the shoulder belt guide .....	33-35
Usable seatbelt to install the child seat .....	5-6	Installation in the vehicle.....	36
Seatbelt/seat not proper for installation .....	7	Riding your child on the child seat.....	37
Warning/Caution .....	7-11	Verification after installation.....	38
In an emergency .....	11		
<b>2. Packing Contents and Parts Identifications ....</b>	<b>12-14</b>	<b>6. Maintenance.....</b>	<b>39-45</b>
<b>3. Before Use.....</b>	<b>15-16</b>	Removing the holding cushions (SWING MOON premium only) .....	39
How to recline .....	15	Removing the body cover .....	40-41
How to adjust the headrest .....	16	Reattaching the cover.....	42-43
<b>4. Usage in Child Style.....</b>	<b>17-32</b>	How to use the hold cushions (SWING MOON premium only) .....	44
Preparations before use .....	17-22	Cleaning.....	45
Selecting the suitable shoulder harness passage .....	17	Safekeeping for the child seat .....	45
How to change the height of the shoulder harnesses .....	18-21	Disposing of the child seat.....	45
When the shoulder harness hanger is put in the body (with the shoulder harnesses released).....	22	Specifications.....	45
Installation in the vehicle.....	23-27	<b>MEMO .....</b>	<b>46-47</b>
STEP 1 Preparations before installation.....	23	<b>Where to contact .....</b>	<b>48</b>
STEP 2 How to fix the seatbelt.....	24-25		
STEP 3 How to tighten the seatbelt.....	26-27		
Verification after installation .....	28		
Notes on removing the child seat from a vehicle.....	29		
Placing your child in the child seat .....	30-32		
Removing your child .....	32		

## 4 1. For Safe Usage



### Regarding the Safety Descriptions

The important descriptions are symbolized as follows in these operating instructions:

 <b>Warning</b>	Risk of death or serious injury if not observed
 <b>Caution</b>	Possible exposure to risk of injury or physical damage
 <b>Info</b>	Prudent usage

### Requirements

Give priority to weight if height and age do not meet their requirements.

		Required weight	Height as a guide	Age as a guide
GI	Child style	From 9 to 18 kg	From 75 to 100 cm	Around 1 to 4 years old
				
GII	Junior style	From 15 to 25 kg	From 100 to 120 cm	Around 3 to 7 years old
				

# 1. For Safe Usage

5

## Usable seatbelt to install the child seat

This child seat can be used only with a 3-point system seatbelt that is approved in accordance with European Safety Standard ECE Regulation No. 16 or other standard of equal level.

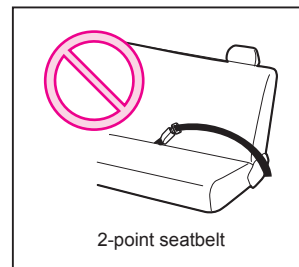
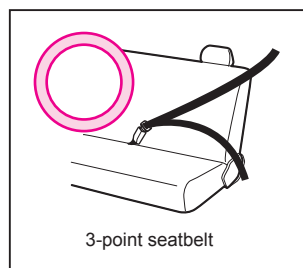

## How to check the conformable types of vehicle

Check in the owner's manual for the vehicle whether or not your vehicle can properly accommodate a "Universal" assistant restraining device for a child. If something is not clear, contact a local dealership or "Where to contact" on the back cover.

## 6 1. For Safe Usage

### Type of Seatbelt

**Note:** Refer also to the manual for your vehicle for the type and use of the seatbelt.

Type of seatbelt	Features of the seatbelt	Cautions during use	Availability
<b>ELR</b> (with Emergency Locking Retractor) Except for one with ELR in its waist belt.	The seatbelt is automatically retracted and locked by rapid pull in a sudden stop or collision.	Upon installation, draw the seatbelt out slowly.	Yes
<b>ALR/ELR</b> (with Automatic Locking Retractor and ELR)	In addition to the features ELR, ALR locks the seatbelt when it is drawn out all the way so that it can be retracted only. The seatbelt is unlocked when it is completely retracted.	To avoid activating ALR, do not draw the seatbelt longer than necessary upon installation. <b>⚠ Warning</b> Take care that the child will not bind his/her neck with the seatbelt, especially in Junior style.	Yes
<b>ALR</b> (with Automatic Locking Retractor)	The seatbelt is locked at the point where it is drawn out and stopped.	To avoid locking the seatbelt in the middle of drawing, draw it out all the way before installation.	Yes
<b>NR</b> (manual handling type)	The length of the seatbelt is adjusted manually.	Adjust the length of the seatbelt before installation.	Yes
<b>Others</b>	Other than the above.	<b>This child seat cannot be installed.</b>	No





# 1. For Safe Usage

7



## Seatbelt/seat not proper for installation

**Warning** As the following are very important with regard to installation/usage, read them carefully.

### Reasons related to equipment of a vehicle

- Passenger seat equipped with an airbag  
An airbag presents risk of serious injury or death of a child in a child seat because the airbag adds high pressure to a child if it opens. If it is possible to inactivate the airbag, do so in accordance with the instructions in the owner's manual for the vehicle. (A seat with only a side or curtain airbag can be used.) Also check the law or regulation in the country where the child seat is used. 
- Passenger seat oriented toward left/right or rear  
The child may be thrown out in a collision. 
- Passenger seat that will be an obstacle for other passengers (vehicle with a seat at the entrance of one side door)  
The child seat may prevent escape in an emergency. 
- Passenger seat with damaged seatbelt  
The child seat with a child may be thrown out in a collision.  
Replace such damaged seatbelt at a dealership. 
- Auxiliary seat or an exclusive seat for an infant
- Rugged seat like a sports seat
- Passenger seat in which the child seat contacts some structure like a pillar or door

### On the type of seat or seatbelt

- Passenger seat with 2-point seatbelt
  - Sports seat or passenger seat equipped with sports-type seatbelt  
Except for cases in which AILEBEBE conformance information gives approval. 
  - Passenger seat without seatbelt  
The child seat cannot be installed. 
  - Passenger seat with passive seatbelt (that is automatically tighten when the door is closed)
  - Seatbelt with ELR (Emergency Locking Retractor) in its waist belt.
  - Other seatbelts (that are not stated in "Installable Seatbelt" on page 5).
- Caution**
- Leather seat  
The child seat may leave marks or impressions after it is removed.

## 8 1. For Safe Usage

### Storage/not in use

**Warning** As the following are very important with regard to installation/usage, read them carefully.

- Even while the child seat is not in use, it must be fixed to a passenger seat with its seatbelt. It may roll around in the vehicle in a sudden stop and cause an accident.

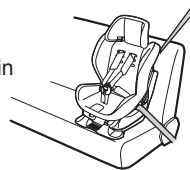

- If the child seat has received impact in a collision or was dropped from a passenger seat, stop using it. Its strength may be compromised, even if its appearance has not been damaged. Such a child seat must be disposed of after writing "Disposal" or "Broken by accident" on its body conspicuously with a marker pen or equivalent.

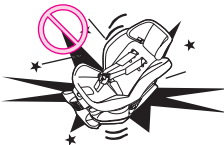

- Do not carry the child seat with a child seated. They can be so unstable as to be dropped. (See "How to carry properly" on page 8.)



- Do not modify the child seat, and do not install or use it in any way other than stated in the operating instructions. Its performance may be insufficient.

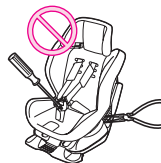

- When you carry the child seat, do not touch the reclining lever or the belt guide.



- When you carry the child seat, do not hold it by only the headrest.



### Information

#### How to carry properly

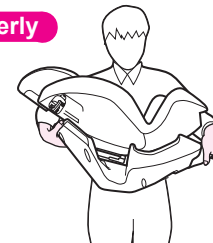



# 1. For Safe Usage

## Before use

**Warning** As the following are very important with regard to installation/usage, read them carefully.

- Do not use the child seat with its cover or cushion removed. Do not attach a cover or cushion that is not specified by our company.



- Secure the child seat in place only with the seatbelt. If not, it may be dropped from the passenger seat or thrown out with a child inside in a collision. Do not use a commercially available strap or rope.



- Do not install the child seat on a cushion. Its performance will be compromised.



- Before installation, extract the buckle from the holder.



- Before installation, remove the seatbelt keepers.

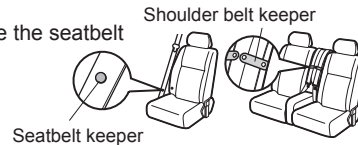

## Caution

- Before use in the child style, be sure to check that the shoulder harness hanger on the rear is set inside the base.

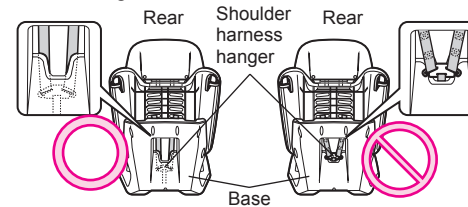

- As this child seat is designed for use inside the vehicle, do not use it in any other places.



- Any loose items in the vehicle that may be cause of injury in a collision must be fixed inside the vehicle or stored in a trunk.

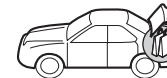

- Do not expose the child seat to direct sunlight. As the metal fittings get so hot that they may burn someone, check that they are not too hot before use.



- The child seat may leave marks or impressions on a passenger seat after it is removed.

## 10 1. For Safe Usage

### During use

**Warning** As these are very important with regard to installation/usage, read them carefully.

- Do not slide or recline the passenger seat on which the child seat is installed. Its seatbelt may be loosened.



- Do not leave your child in the vehicle alone. A guardian must stay there. Especially in summer, there is a risk of heat sickness inside the vehicle.



- Do not let a child not meeting the requirements sit on the child seat.



- Take care not to pinch your finger with a movable part while reclining the child seat. Especially be careful about other little passengers.



- The child seat cannot be installed facing rear.

- The child seat must not be adjusted or handled during driving. Stop the vehicle in a safe location, then install the child seat or check its condition.



- Let a child sit in a proper posture stated in the operating instructions. Do not let him/her stand, be in a half-sitting position, or sit on his/her feet.



- Check if there is a toy or something in a pocket of the child's clothes. It may be a cause of injury if tucked between the child seat and the child.



- When the child seat is used with a junior style, adjust the seatbelt not to press against the child's neck. (For how to adjust the height of the headrest, see page 16.)



- Be careful that a child does not wind the seatbelt around his/her neck. A seatbelt with ALR/ELR function is especially dangerous, as it can be locked on the way.



# 1. For Safe Usage

## During use

### ⚠ Caution

- During installation or use, be careful not to pinch the child seat or seatbelt with a door or passenger seat.
- If a fastener tape of a child's shoes or clothes scratches the cover of the child seat, the fabric of the child seat may be damaged.
- If a fastener tape of the child seat scratches clothes, they may be damaged.



### 👉 Information

- Take a break for your child. A long drive tires him/her.
- Abstain from giving foods or drinks to your child while the vehicle is moving, to avoid choking.

## Securing your workspace

- Install the child seat in a vehicle in an open and level place so that the child seat can be carried easily and the doors can be opened fully.
- Expand the workspace inside the vehicle by folding and/or sliding forward the seat in front of the seat on which the child seat will be installed.
- Slide back the passenger seat, if it is slidable, on which the child seat will be installed.

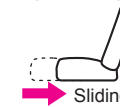
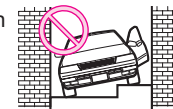

### ⚠ Caution

Do not slide the passenger seat after installation.

### In an emergency

Unfasten the seatbelt and take refuge in a place of safety immediately.

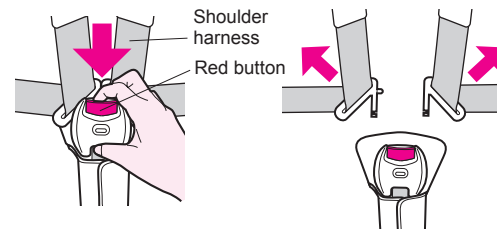

## 12 2. Packing Contents and Parts Identifications

First check the packing contents. If any part is missing, contact one of the service centers listed on the back cover.

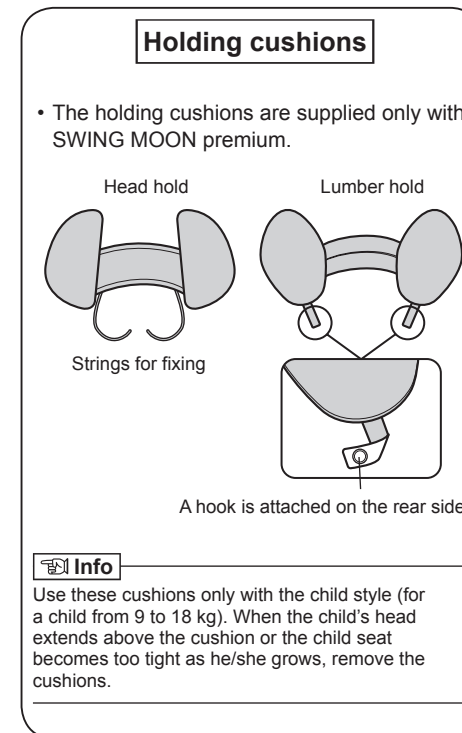
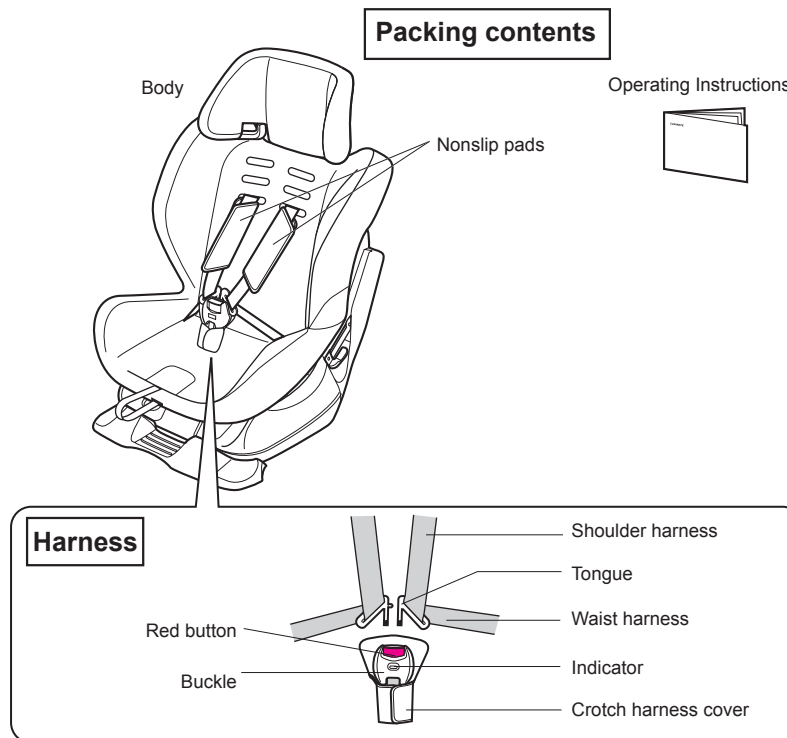

## 2. Packing Contents and Parts Identifications

13

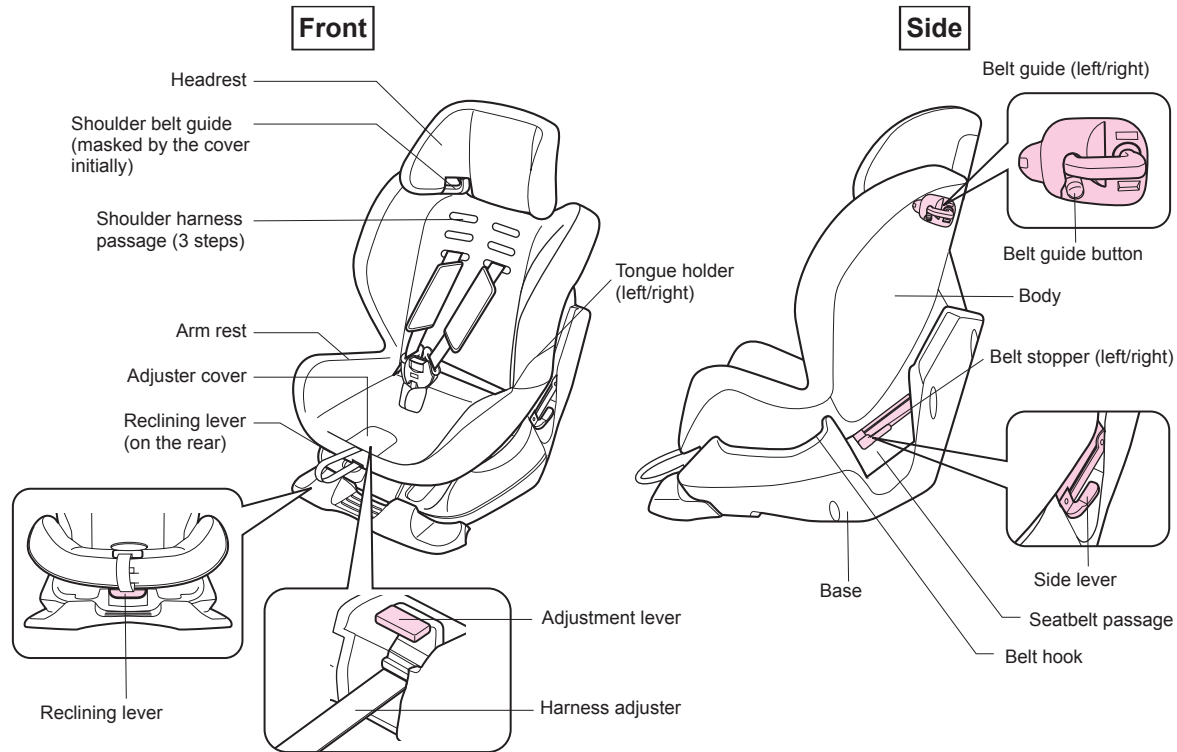

## 14 2. Packing Contents and Parts Identifications

### Rear

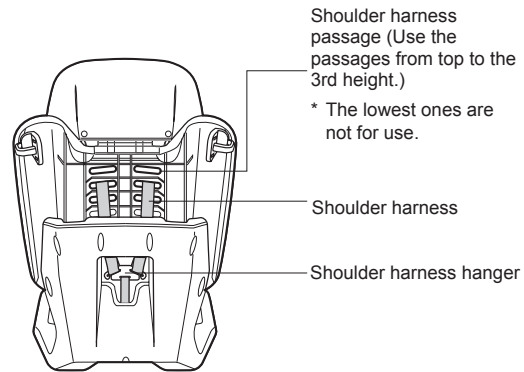

### Identifications of the seatbelt on the vehicle

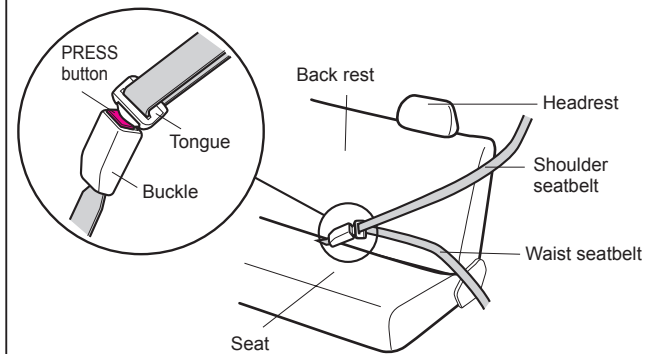

#### Info

The seatbelt reaching higher than the tongue is called the shoulder seatbelt, and the lower is called the waist seatbelt in these operating instructions.

### 3. Before Use

#### How to recline

The child seat can be reclined in 3 steps.

#### Child/Junior style

[Weight of more than 9 kg, forward facing]

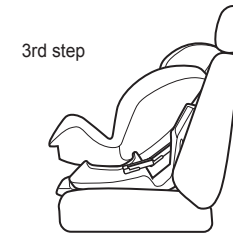

While supporting the child seat with one hand, hold up the reclining lever and recline the child seat back and forth with both hands.

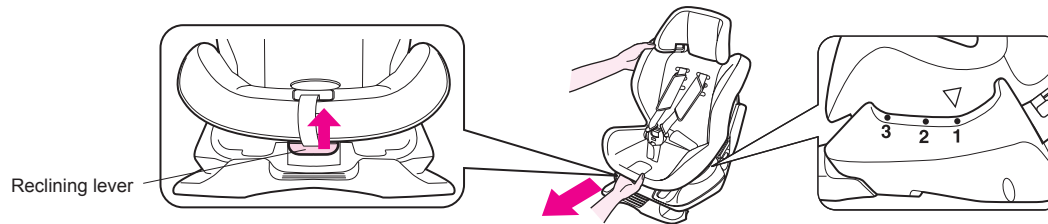

#### Info

The child seat may be pressed to the passenger seat because of the reclining step. It does not affect performance.

## 16 3. Before Use

### How to adjust the headrest

Hold the headrest with both hands and move it up and down.

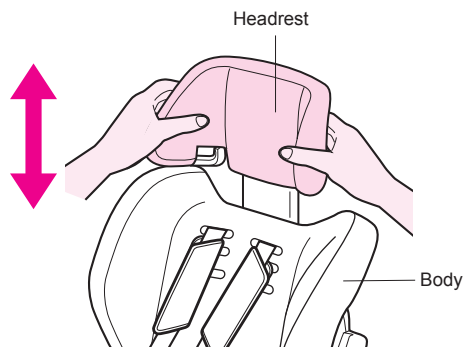

**⚠ Caution**

Take care not to pinch your fingers between the headrest and the body.



## 4. Usage in Child Style

17

### Preparations before use

### Selecting the suitable shoulder harness passage

**Info** The shoulder harnesses are set in the 3rd weight position of the passages initially.

Change the height of the shoulder harness as your child grows. Before installation, pass the shoulder harnesses through the passages in the suitable height for your child.

**Child style** (for a child more than 9 kg weight)

1st height  
2nd height  
3rd height

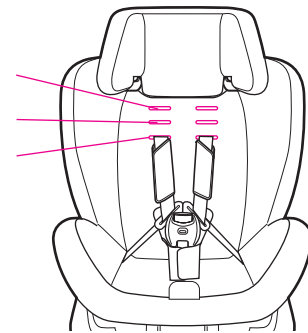

Use one of the heights from 1st to 3rd.

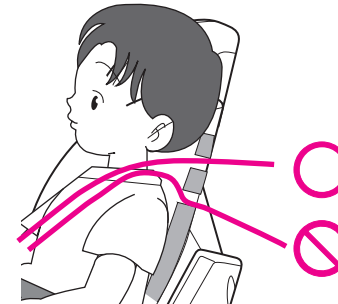

Pass the shoulder harness through the passages just above the child's shoulders.

**Warning**

Select the most suitable passages for your child. If not, the performance of the child seat may be compromised in an accident.

## 18 4. Usage in Child Style

### Preparations before use

### How to change the height of the shoulder harnesses

- 1** First, set the child seat to the 1st step of reclining so that the rear of the body can be seen.  
(For how to recline, see page 15.)

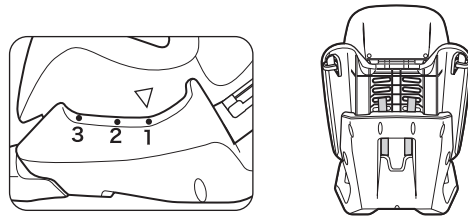

- 2** While holding the adjustment lever up, draw out the shoulder harness fully from the rear of the body.

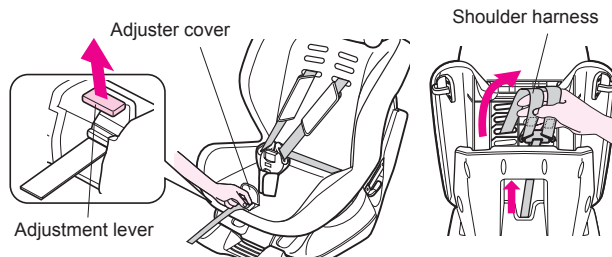

- 3** Release the shoulder harnesses from the shoulder harness hanger.

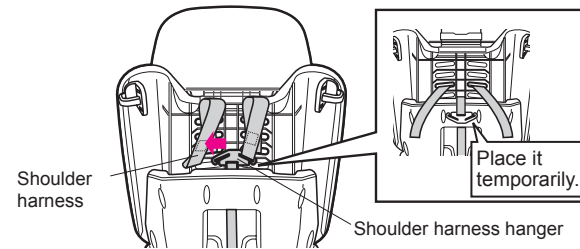

- 4** Draw out the shoulder harnesses from the front.

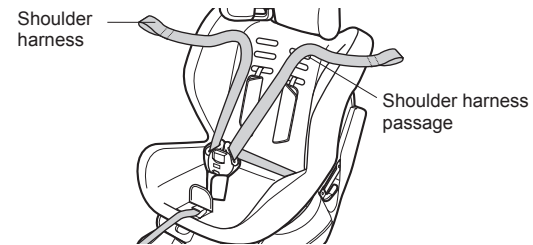

#### Info

The shoulder harnesses and nonslip pads cannot be drawn out together.

## 4. Usage in Child Style

19

- 5** Pass the nonslip pads to their middle into the shoulder harness passages from the front.

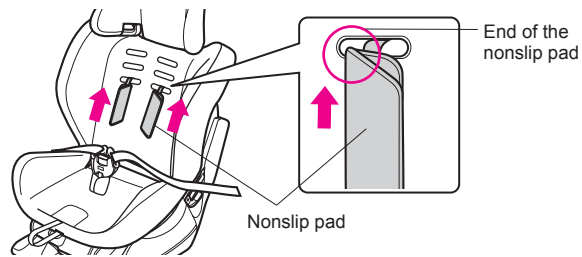

- 6** Draw them out from the rear.

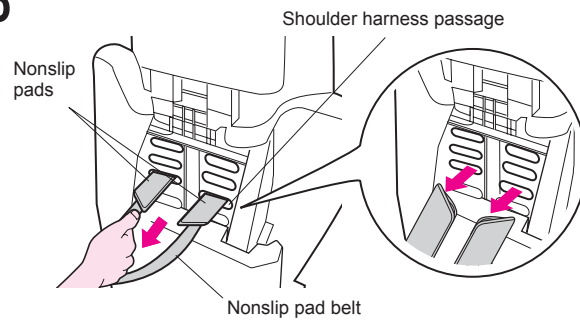

- 7** Insert the ends of the nonslip pads from the rear with, facing their nonslip sides facing the child's body, into the suitable shoulder harness passages then draw them out from the front. (For selecting the suitable shoulder harness passage, see page 17.)

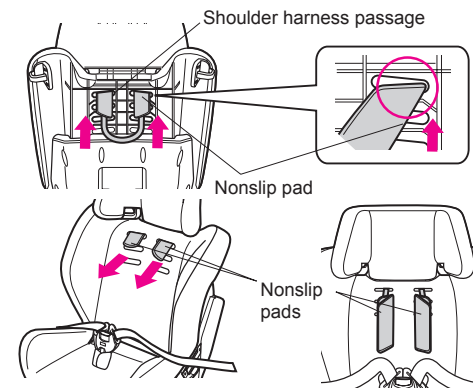

### Info

Insert the nonslip pads with their nonslip sides facing the child's body into the shoulder harness passages.

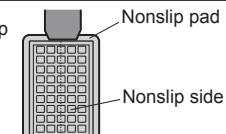

## 20 4. Usage in Child Style

### Preparations before use

### How to change the height of the shoulder harnesses

- 8** Pass the shoulder harnesses through the nonslip pads then through the harness passages into which the nonslip pads go.

(For selecting the suitable shoulder harness passage, see page 17.)

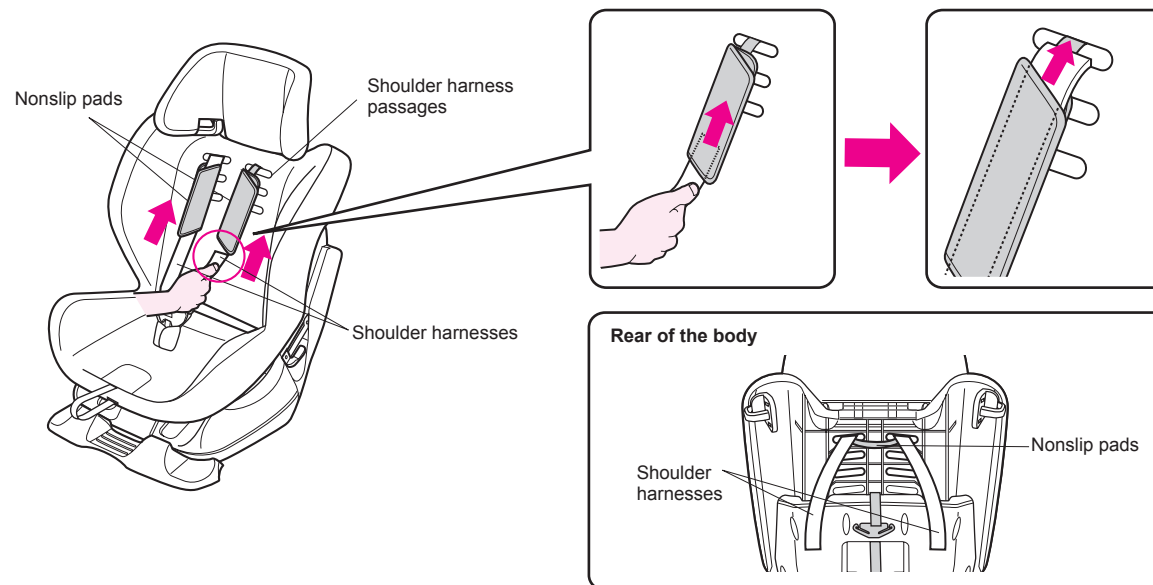

## 4. Usage in Child Style

21

**9** Fit the shoulder harnesses on the shoulder harness hanger then store them inside the base. See the illustrations as for the positions of shoulder harness passages and shoulder harnesses.

**Child style** (for a child more than 9 kg weight)

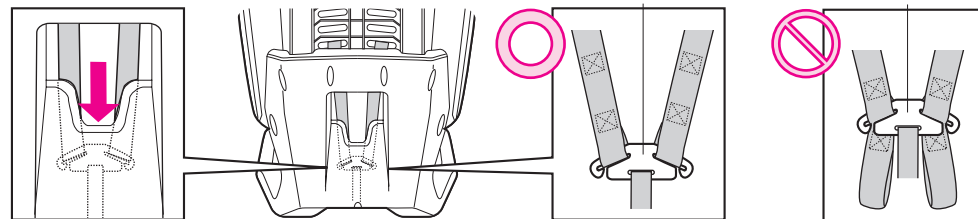

**Warning**

- Fit the shoulder harnesses so that the cuts of the hanger are visible. If not, the shoulder harness may come off the hanger.
- Be careful not to hang partials of the shoulder harnesses on the harness hanger.
- Check that the shoulder harnesses are not twisted.
- Be sure to put the shoulder harness hanger inside the base.

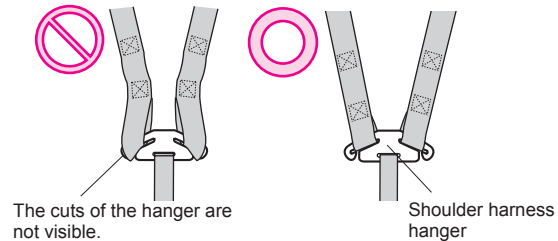

## 22 4. Usage in Child Style

### Preparations before use

### When the shoulder harness hanger is put in the body (with the shoulder harnesses detached)

- 1 While holding the adjustment lever up, push the harness adjuster inside little by little.

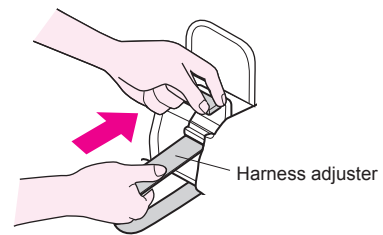

- 2 Insert your hand into the body from the rear to draw out the shoulder harness hanger.

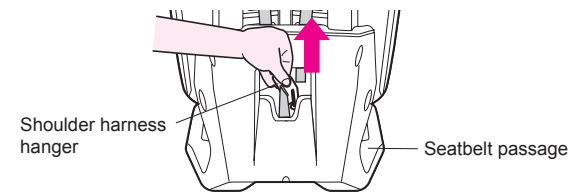

#### Info

The shoulder harness hanger can be drawn out from the seatbelt passage.

## 4. Usage in Child Style

23

### Installation in the vehicle

#### STEP 1 Preparations before installation

- 1 Set the child seat to the 1st step of reclining.**  
(For how to recline, see page 15.)

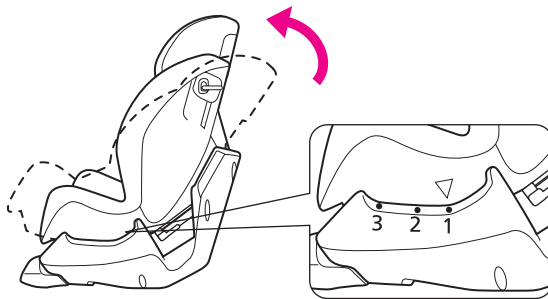

- 2 Place the child seat on the passenger seat facing forward then press it so that its base is pressed against the backrest and the seat of the passenger seat firmly.**

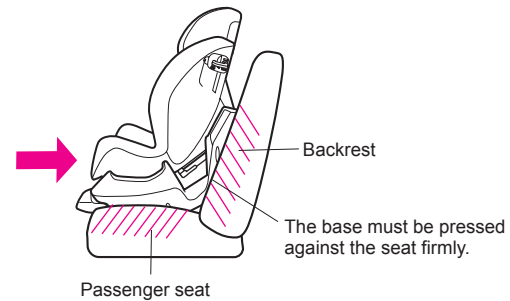

#### Info

- If the passenger seat can be reclined, adjust the height of its backrest so that the base will be pressed firmly against it.
- If the base cannot be pressed because of the headrest of the passenger seat, remove the headrest.

## 24 4. Usage in Child Style

### Installation in the vehicle

#### STEP 2 How to fix the seatbelt

- 3** Turn over the adjuster cover and draw out the harness adjuster until the shoulder harnesses are extended thoroughly.

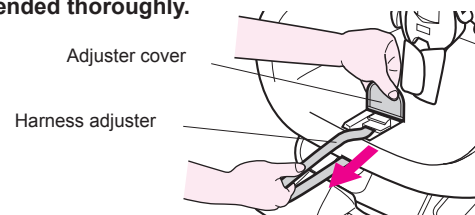

**Warning**

When the shoulder harnesses are loosened, it is difficult to pass them through the seatbelt passage; therefore, they may be passed through improperly.

- 4** Draw out the seatbelt so that the shoulder seatbelt and waist seatbelt can be fit together for a length of about 50 cm long.

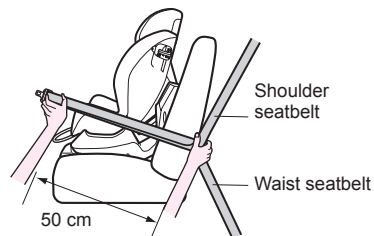

- 5** Pass the seatbelts fit together through the seatbelt passage until they come out from the opposite side then insert the tongues into the buckle until it clicks.

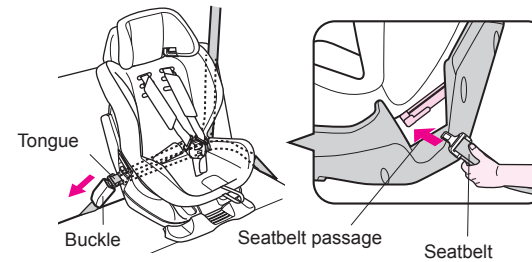

**Warning**

- Do not pass the seatbelts through the belt stopper.
- Do not pass the seatbelt also through the belt stopper on the opposite side.

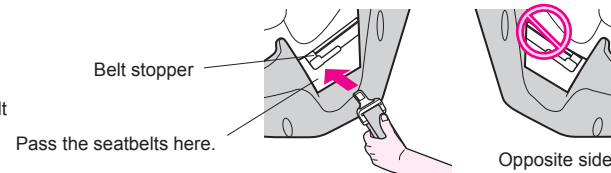



## 4. Usage in Child Style

25

- 6** Hang the waist seatbelt, which is on the opposite side of the buckle, on the belt hook.

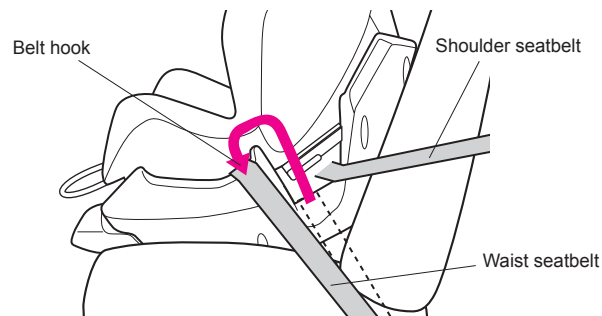

**Info**

If the waist seatbelt is difficult to hang on the belt hook, pass the shoulder seatbelt toward the buckle.

- 7** Pull the shoulder seatbelt strongly in the direction of the arrow while holding the child seat with your hand, as shown in the illustration.

**Opposite side of the buckle**

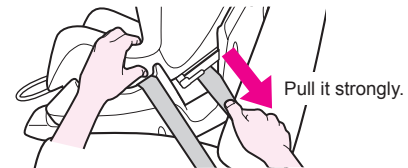

**Passenger seat without a side door**

Put your weight with one knee on the child seat and pull up the shoulder seatbelt to tighten the waist seatbelt.

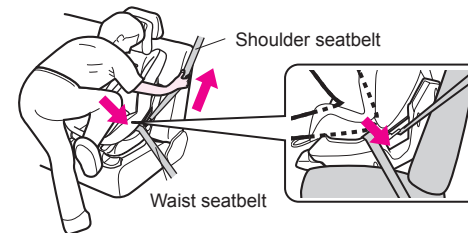

## 26 4. Usage in Child Style

### Installation in the vehicle

#### STEP 3 How to tighten the seatbelt

- 8** Open the belt stopper. While fastening the shoulder seatbelt with the belt stopper, lock them firmly with the side lever.

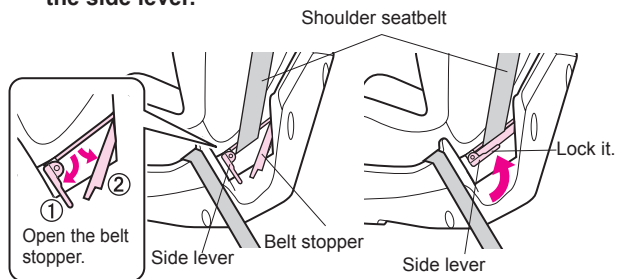

#### **Warning**

- Insert the shoulder seatbelt with the belt stopper securely so it will not become twisted.
- Be sure to pull up the side lever all the way to lock.
- Do not use the belt stopper on the buckle side.

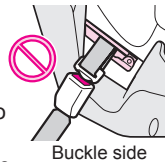

#### **Caution**

- Be careful not to let the seatbelt be pinched by the side lever.

- 9** Put your weight with one knee on the child seat and pull up the shoulder seatbelt to tighten the waist seatbelt.

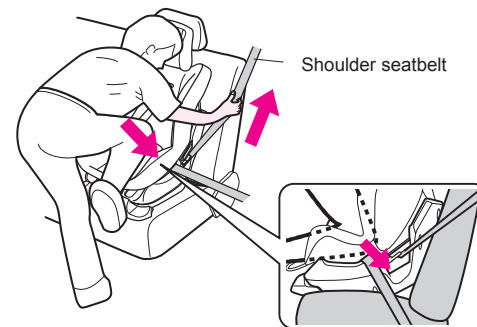

#### **Warning**

The seatbelt cannot be settled (the vehicle seatbelt on the buckle side is too long, for example) with the tongues installed in the buckle.

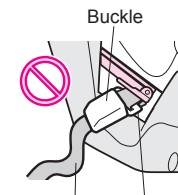

Seatbelt on the buckle side

## 4. Usage in Child Style

27

**10** See the following illustrations 1 to 3. While pressing the belt guide button, turn the ring segment downward, pass the shoulder seatbelt through the belt guide then turn the ring segment upward to lock.

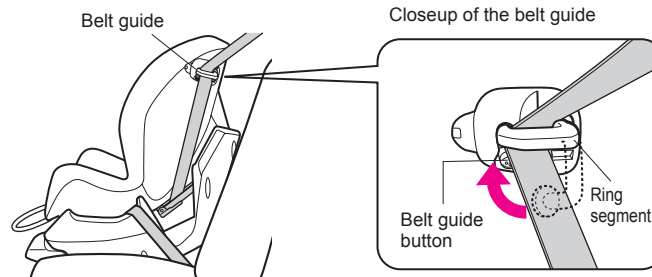

**Warning**

- Be sure to lock the ring segment of the belt guide.
- Do not use the belt guide of the buckle.

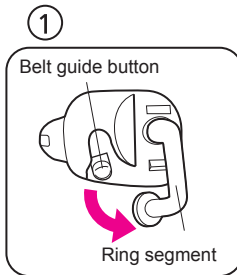

While pressing the belt guide button, turn the ring segment downward to release.

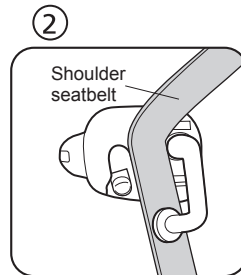

Pass the shoulder seatbelt through the ring segment.

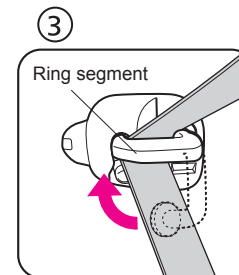

Turn the ring segment upward to lock.

## 28 4. Usage in Child Style

### Verification after installation

#### Completion from the buckle side

It is not necessary to use the belt guide.

The seatbelt of the vehicle is not loosened or twisted.

It is not necessary to use the belt stopper.

The tongue of the seatbelt is inserted firmly into the buckle.

Do not hang the seatbelt on the belt hook.

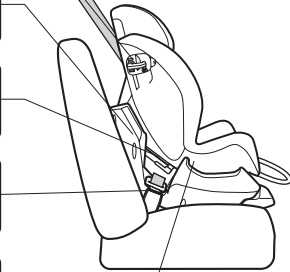

#### Completion of opposite side

The shoulder seatbelt is passed through the belt guide securely.

The shoulder seatbelt is fastened with the belt stopper securely.

The belt stopper is securely locked.

The waist seatbelt is hung on the belt hook.

If force is applied to the child seat, its base should not move more than 2 cm to left, right, front, or back.

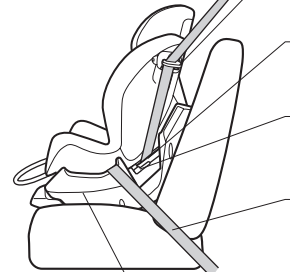

#### Info

If there is any point that is different from the completed configuration, install the child seat again from the beginning.

## 4. Usage in Child Style

29

### Notes on removing the child seat from a vehicle

If the buckle of the passenger seat cannot be released because it goes inside the belt passage, try either of the following:

- Ⓐ Release the belt stopper of the child seat and draw out the buckle of the passenger seat. Then release the buckle.
- Ⓑ Use a ruler or equivalent to release the buckle of the passenger seat.

Ⓐ ① Release the belt stopper.

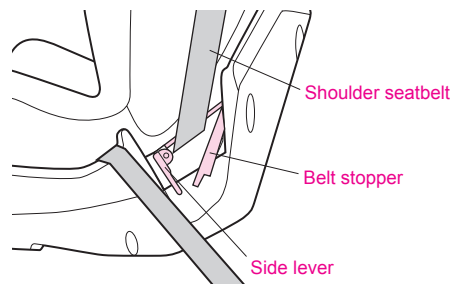

② Draw out the buckle of the passenger seat then release the lock.

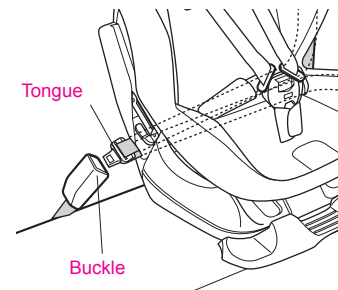

## 30 4. Usage in Child Style

### Placing your child in the child seat

- 1 While holding up the adjustment lever, draw out the shoulder harness.

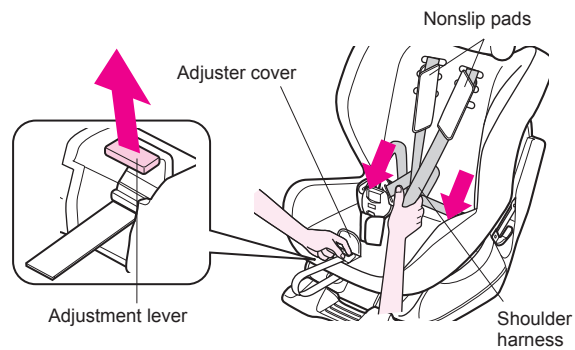

- 2 Push down the red button of the buckle to release the tongue.

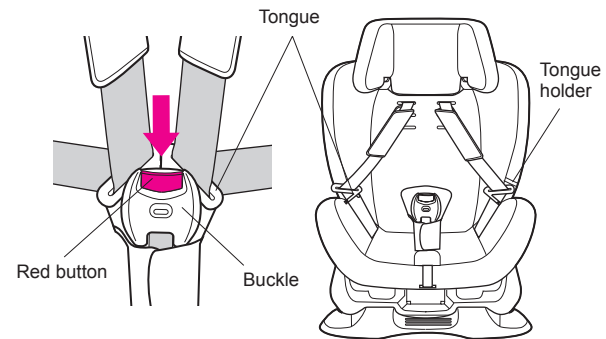

#### Info

Hang the released tongues on the tongue holders on each side so that it will be easy to place or remove your child on or from the child seat.

## 4. Usage in Child Style

31

**3** Place your child in the correct position.

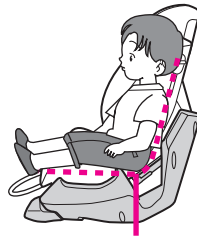

Have him/her sit in deeply.

**4** Pass the child's arms under the shoulder harness, and put the left and right tongues together and insert them into the buckle. Check that the indicator lights in green.

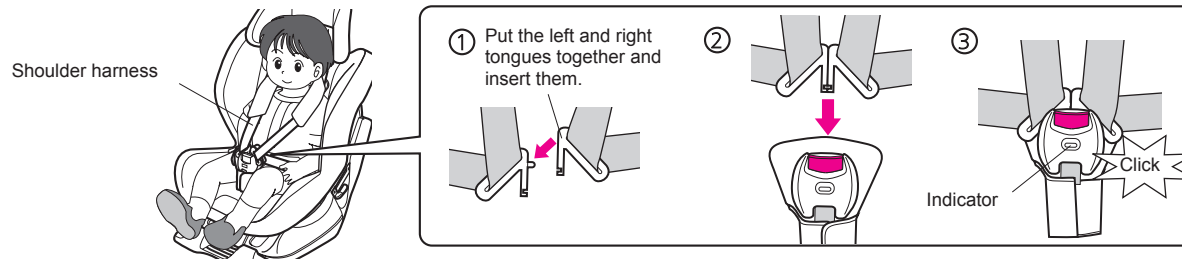

**Info**

The left and right tongues cannot be inserted into the buckle if they are not put together.

**Warning**

Be careful that no foreign object has gotten inside the buckle. If it has, do not use it anymore and contact a Carmate service center listed on the back cover. (It will be repaired in our repair factory.)

## 32 4. Usage in Child Style

### Placing your child in the child seat

- 5** Pull the nonslip pads downward strongly and draw the harness adjuster to tighten the shoulder harness until one or two fingers of an adult can be inserted between the shoulder harness and the child's chest.

**Warning**

- Check that the shoulder harnesses are not twisted or loosen and that the waist harness fastens around the child's pelvis.
- Check that the tongues are inserted into the buckle until they are securely locked.
- When you place your child, draw the nonslip pads forward until the seatbelt behind the child seat is tight.
- Face the nonslip sides of the nonslip pads toward the child's body.

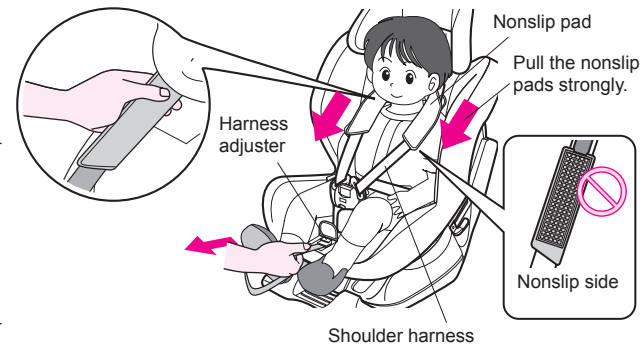

### Removing your child

- 1** While holding up the adjustment lever, draw and loosen the shoulder harnesses.

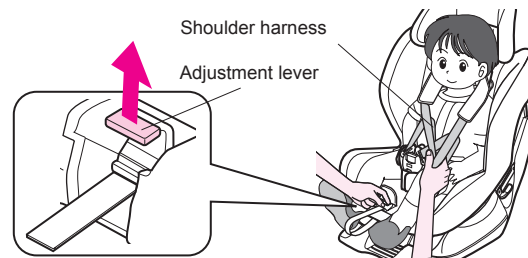

- 2** Press the red button of the buckle to release the tongues.

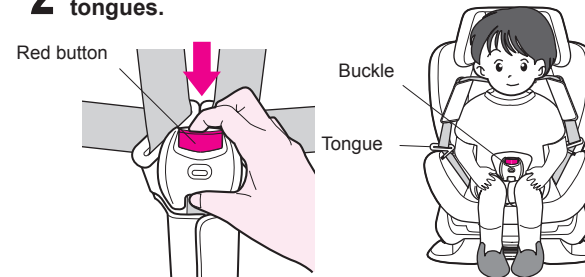



## 5. Usage in Junior Style

33

As for a child whose weight is from 15 to 25 kg, use the seatbelt of the passenger seat to fasten him/her instead of the harnesses of the child seat.

### Preparations before use

### Storing the harnesses/Preparation of the shoulder belt guide

If your child seat is the SWING MOON premium, remove the holding cushions. (See "Removing the holding cushions" on page 39.)

- 1 Set the child seat to the 1st step of reclining. Release the shoulder harnesses from the shoulder harness hanger and draw out the harnesses.**  
(For how to release the shoulder harnesses, see page 18.)

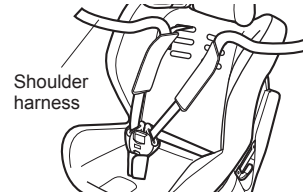

- 2 Remove the nonslip pads and crotch harness cover. Release the tongues from the buckle. \*Store the removed parts.**

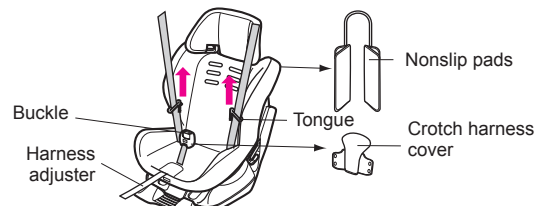

- 3 Release the 4 hooks of the seat part of the body cover and turn up the cover. Release the 2 hooks (left and right) at the end of each of the two black elastic strings inside the cover from the back hook holes. Draw out the buckle and the waist harness from the body cover toward its rear. (See "Removing the body cover" on page 40.)**

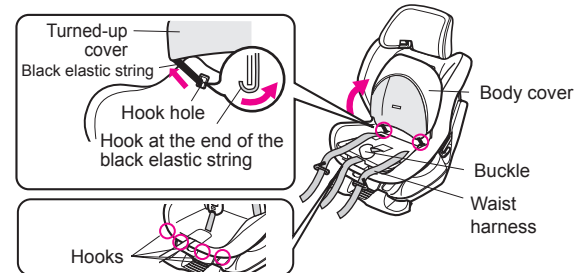

- 4 Release the 2 seat hooks and remove the seat cushion (upper).**

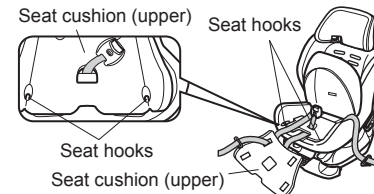

## 34 5. Usage in Junior Style

### Preparation before use

### Storing the harnesses/Preparation of the shoulder belt guide

- 5** Turn up the seat cushion (lower) and bind the tongues with the harness and put them in the hole on the seat.

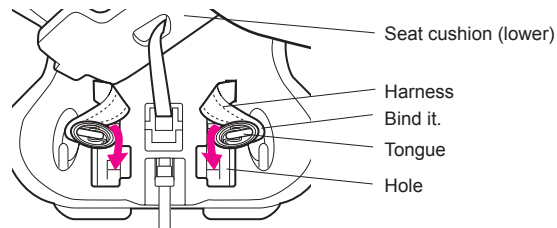

- 6** Restore the seat cushion (lower) and place the buckle in front of it. Then place the seat cushion (upper) on them and fix with the left and right hooks.

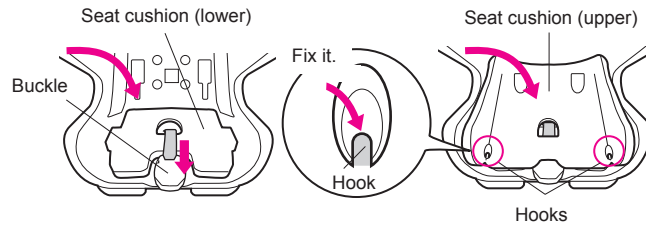

#### Info

The seat cushion (upper) can be placed over the hooks lightly.

- 7** Fix the 2 hooks (left and right) at the end of each black elastic strings inside the cover. Place the body cover on the seat and fix it with 4 hooks.

\* If it is difficult to fix the hooks at the ends of the black elastic strings, first release the 2 hooks of the body cover to make it easy. Then try again to fix the released hooks.

Rear of the body cover

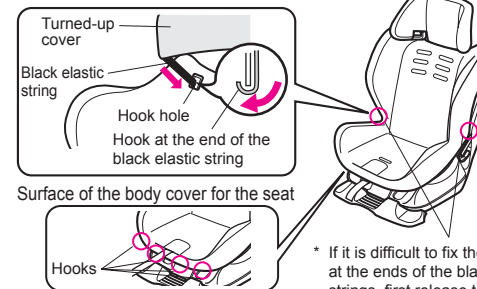

\* If it is difficult to fix the hooks at the ends of the black elastic strings, first release the hooks.

#### Caution

If the child seat is set to the 2nd or 3rd step of reclining, the inner hook of the cover can be put in an improper hole, in which case it may be possible that the child seat cannot be reclined.

## 5. Usage in Junior Style

35

- 8** Place the shoulder harness hanger in the groove on the rear temporarily and set the child seat to the 3rd step of reclining. Then pull the harness adjuster fully. Wind the surplus length of the harness and store it below the adjustment lever.

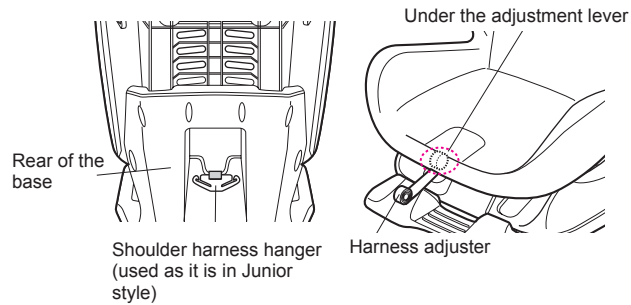

- 9** In Junior style, insert the belt guide cover inside the shoulder belt guide so that the shoulder belt guide is visible. (Initially it is behind the cover.)

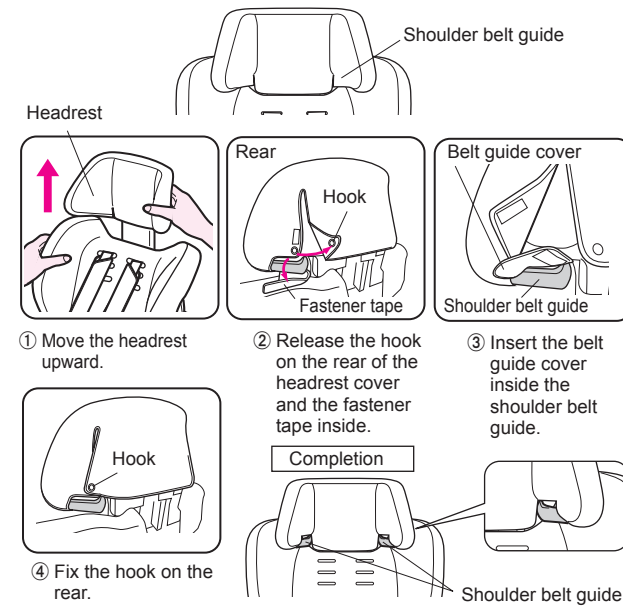

## 36 5. Usage in Junior Style

### Installation in the vehicle

Place the child seat on the passenger seat facing forward and press it so that its base is pressed against the backrest of the passenger seat.

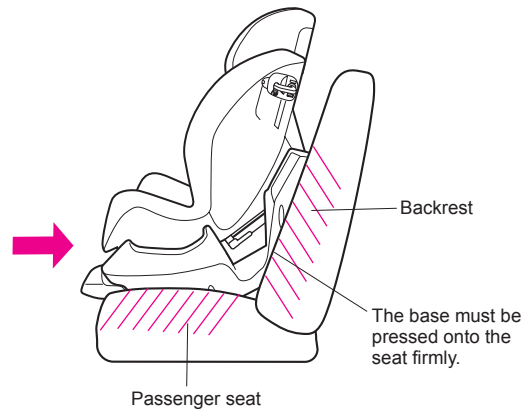

#### Info

- If the passenger seat can be reclined, adjust the height of its backrest so that the base can be pressed firmly.
- If the base cannot be pressed firmly because of the headrest of the passenger seat, remove the headrest.

#### Warning

Even while the child seat is not in use, it must be fixed to a passenger seat with its seatbelt. It may roll around in the vehicle in a sudden stop and cause an accident.

## 5. Usage in Junior Style

37

### Riding your child on the child seat

- 1 Press the buckle button of the vehicle to release the seatbelt.
- 2 Have your child sit in the child seat deeply. Pass the waist seatbelt in the grooves of both sides and insert the tongue into the buckle firmly until it clicks.

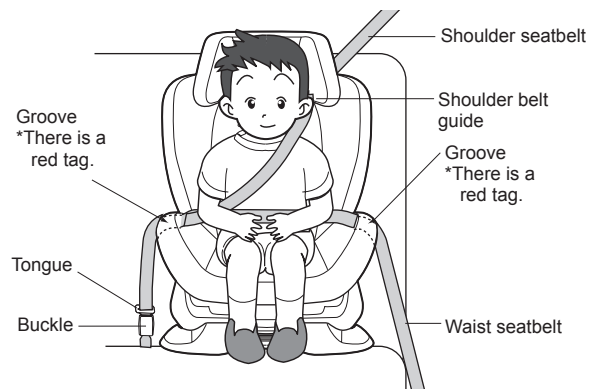

- 3 Pass the shoulder seatbelt through the shoulder belt guide.

Adjust the headrest so that the shoulder seatbelt passes just above the child's shoulder.  
(For how to adjust the headrest, see page 16.)

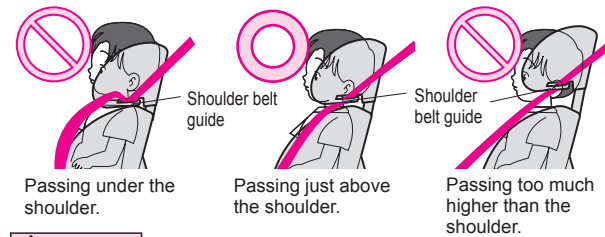
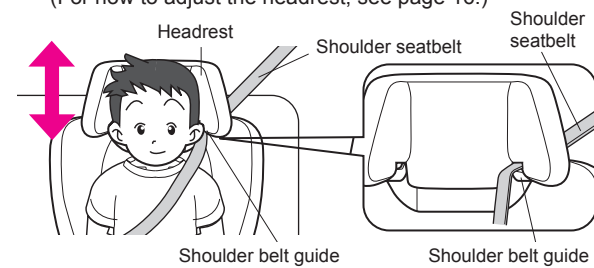

#### **Warning**

The most proper position of the shoulder belt is just above the child's shoulder when he/she is sitting in the child seat.

## 38 5. Usage in Junior Style

\*Be sure to check all points referring to the illustration.

### Verification after installation

#### Completion from the buckle side

The head of the child does not come out from the headrest.

The tongues of the seatbelt are inserted firmly into the buckle.

The seatbelt of the vehicle is not loose or twisted.

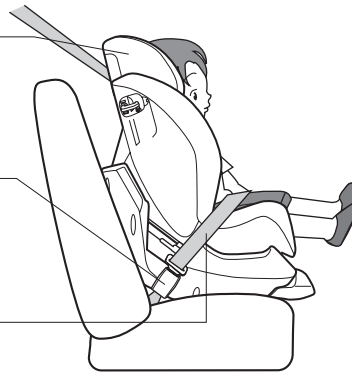

#### Completion of the opposite side

The shoulder seatbelt is passed through the belt guide correctly.

The waist seatbelt is passed through the grooves of both sides on the child seat.

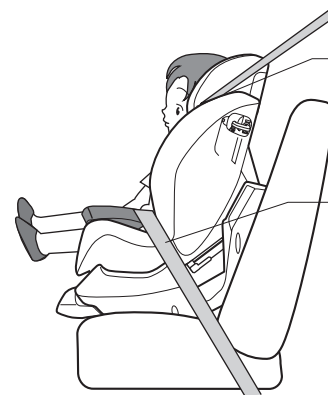

## 6. Maintenance

39

### Removing the holding cushions (SWING MOON Premium only)

#### Head hold

- 1 Move the headrest upward.  
(See “How to adjust the headrest” on page 16.)

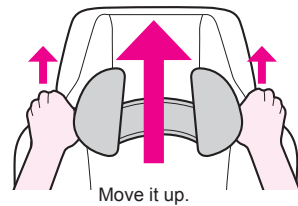

- 2 Remove the strings of the head hold from the headrest bar.

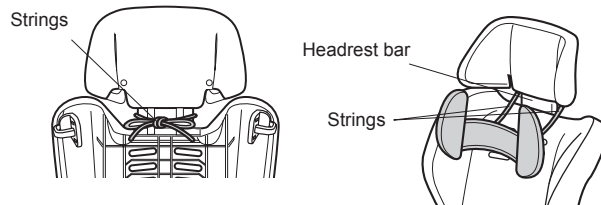

#### Lumber hold

- 1 Pull the lumbar hold to remove the hooked cloth from the waist harness passage. Then release the 2 hooks (left and right).

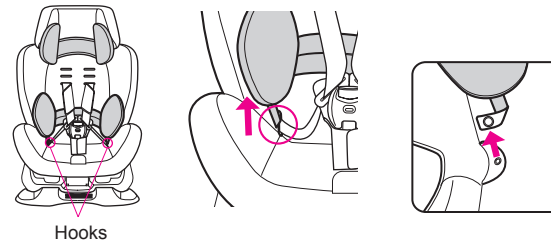

- 2 Remove the lumbar hold from the back of the shoulder harnesses.

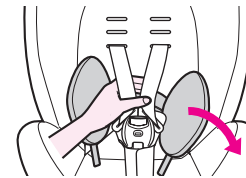

## 40 6. Maintenance

### Removing the body cover

- Set the child seat to the 1st step of reclining.
- Release the tongues from the buckle before removing the body cover.

#### Info

The shoulder harness must be taken off before removing the body cover and shoulder harness cover.

#### Crotch harness cover

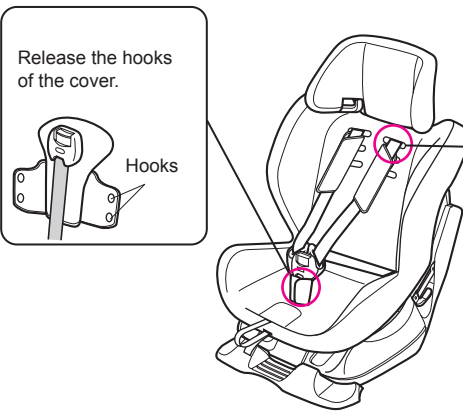

#### Nonslip pads

See pages 18 and 19 for details.

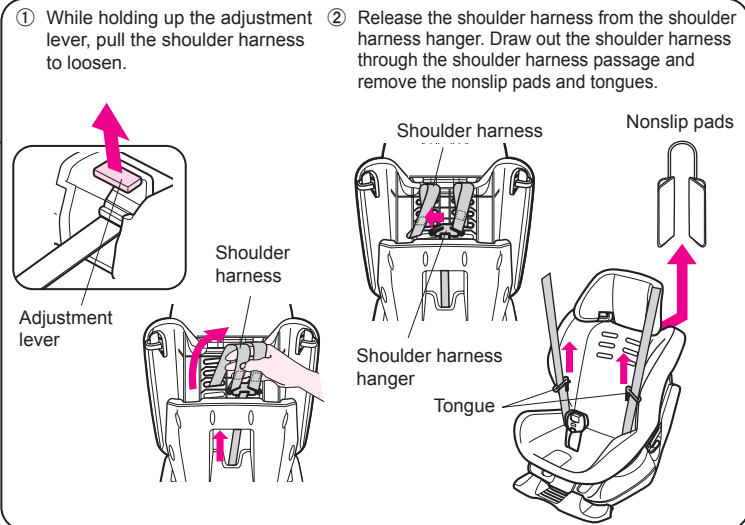



## 6. Maintenance

41

### Body cover

**1** Release the 8 outer hooks and 2 inner hooks.

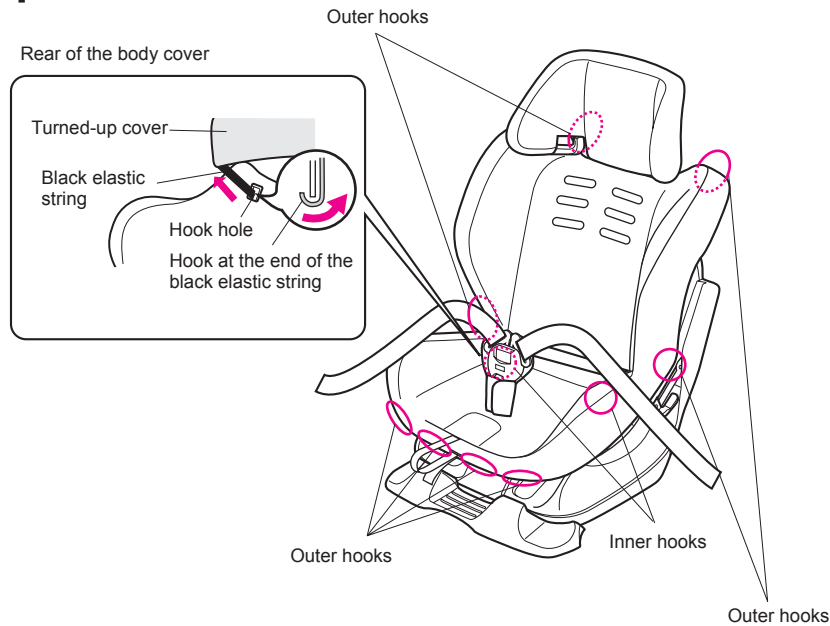

**2** Move up the headrest and release the 2 hooks and 2 fastener tapes of the headrest.

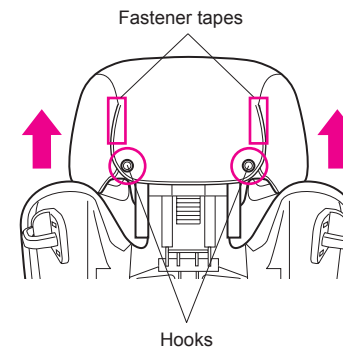

## 42 6. Maintenance

### Reattaching the cover

#### Body cover

- 1** Pass the shoulder harnesses and tongues through the body cover. (child style only)



- 3** Pass the buckle through the body cover and fix the 8 outer hooks (only for the child style).

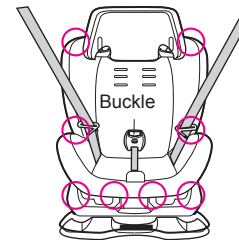

- 2** Cover the seat with the body cover and fix the 2 hooks (left and right) at the ends of the black elastic strings inside the cover.

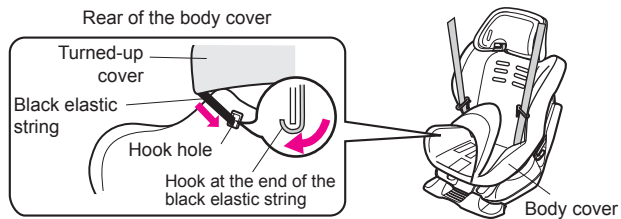

- 4** Cover the headrest with the headrest cover and fix the 2 pieces of fastener tape and 2 hooks.

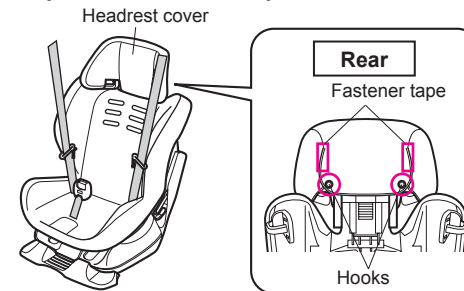

#### ⚠ Caution

If the child seat is set to the 2nd or 3rd step of reclining, the inner hook of the cover can be put in an improper hole, in which case it may be possible that the child seat cannot be reclined.

## 6. Maintenance

43

### **Nonslip pads** (child style only)

Pass the nonslip pads through the harnesses so not to be twisted.

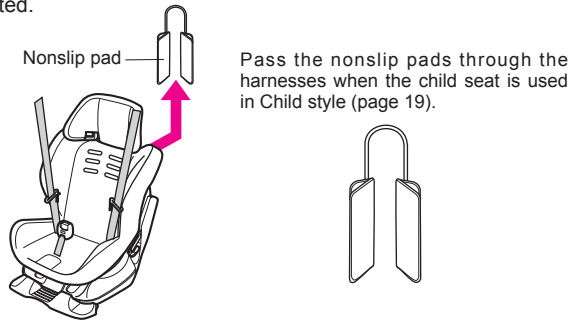

**5** After all covering is finished, pass the shoulder harnesses through the suitable passages and hang them on the shoulder harness hangers.

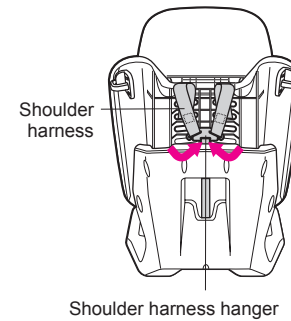

### **Crotch harness cover** (child style only)

Fix the hooks of the cover.

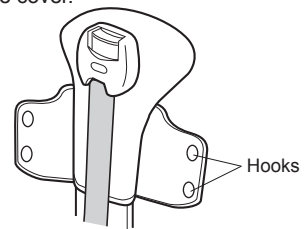

## 44 6. Maintenance

### How to use the hold cushions (SWING MOON Premium only)

#### Head hold

- 1 Draw up the headrest.**  
(For height adjustment of the headrest, see page 16.)

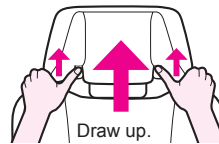

- 2 Tie the strings for fixing of the head hold to the headrest bar.**

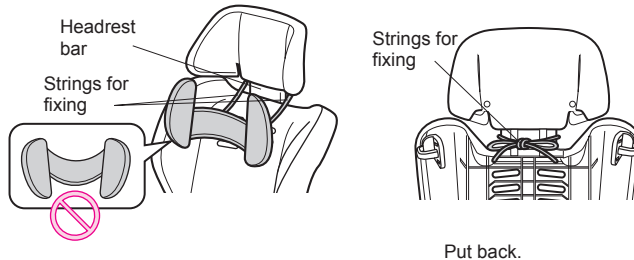

- 3 Put back the headrest.**  
(For height adjustment of the headrest, see page 16.)

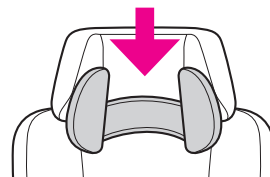

#### Lumber hold

- 1 Pass the lumber hold behind the shoulder harnesses.**  
(Face the side without a hook toward the front.)

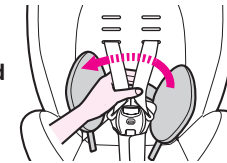

- 2 Draw out the cloth with a hook from the waist harness passage and fit it to the hook of the lumber hold.**

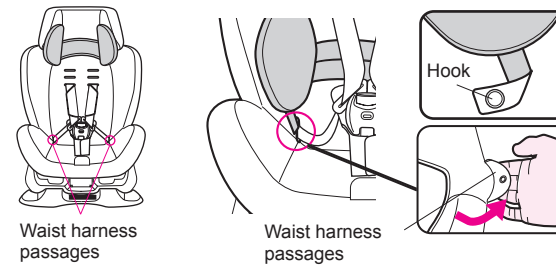

- 3 Tuck the belt of the lumber hold and the cloth fitted together into the waist harness passage.**

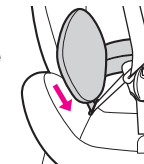







## 6. Maintenance

45

### Cleaning

#### Notes on cleaning

	Wash the product by hand using water under 30°C.
	Chlorine bleach must not be used.
	When ironing, cover with another cloth and iron at low temperature from the surface.
	Do not use dry cleaning.
	Do not wring.
	Fix the form and dry completely by hanging in the shade.

#### Caution

- The nonslip pads cannot be washed.
- The cushions supplied to this child seat cannot be washed. When you wash the holding cushions, remove the cushion inside it. To clean the cushions, soak a cloth in neutral detergent diluted with water and wring it out, then use it to wipe them. Do not use a solvent like a thinner.

#### Info

Urethane foam is used to achieve good cushioning performance. It may become discolored, since that is a property of this material. It does not affect performance.

Nonslip pads

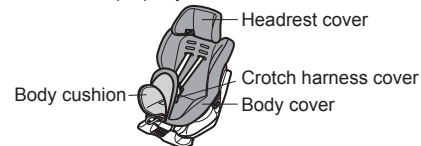

The form and specifications of the body cushion, body cover, headrest cover, and crotch harness cover differ with the type of the product.

#### Warning

Do not use a solvent like a thinner to clean the body or harnesses.

### Safekeeping for the child seat

- Push down the headrest to the lowest and place the footrest in the position of forward-facing use.
- Cover it with any sack, and keep it out of direct sunlight.

### Disposing of the child seat

- Dispose of it in the manner specified by your local government.
- If you dispose of it because of an accident, write "Broken by accident" on its body conspicuously with a marker pen or equivalent.

#### Info

We recommend that you to take a safety check of the seatbelt of the vehicle after an accident at a dealership.

### Specifications

<b>Dimensions</b>	H 710*×W 500×D 550 mm (*in reclining step 1st and with the headrest set lowest)
<b>Mass</b>	8 kg
<b>Materials of the body</b>	Polypropylene (including polyamide and others)
<b>Materials of the body cover and Holding cushions</b>	Polyester (outer material)/ Urethane foam (lining)
<b>Materials of cushions</b>	Polyurethane foam

MEMO

Dotted lines for writing.



MEMO

A large rectangular area with a black border, containing horizontal dashed lines for writing.





48

## Where to contact

### **CAR MATE MFG. CO., LTD.**

5-33-11, Nagasaki, Toshima-ku, Tokyo 171-0051 Japan

E-mail: [int@carmate.co.jp](mailto:int@carmate.co.jp)

Tel: +81-3-5926-1226

